

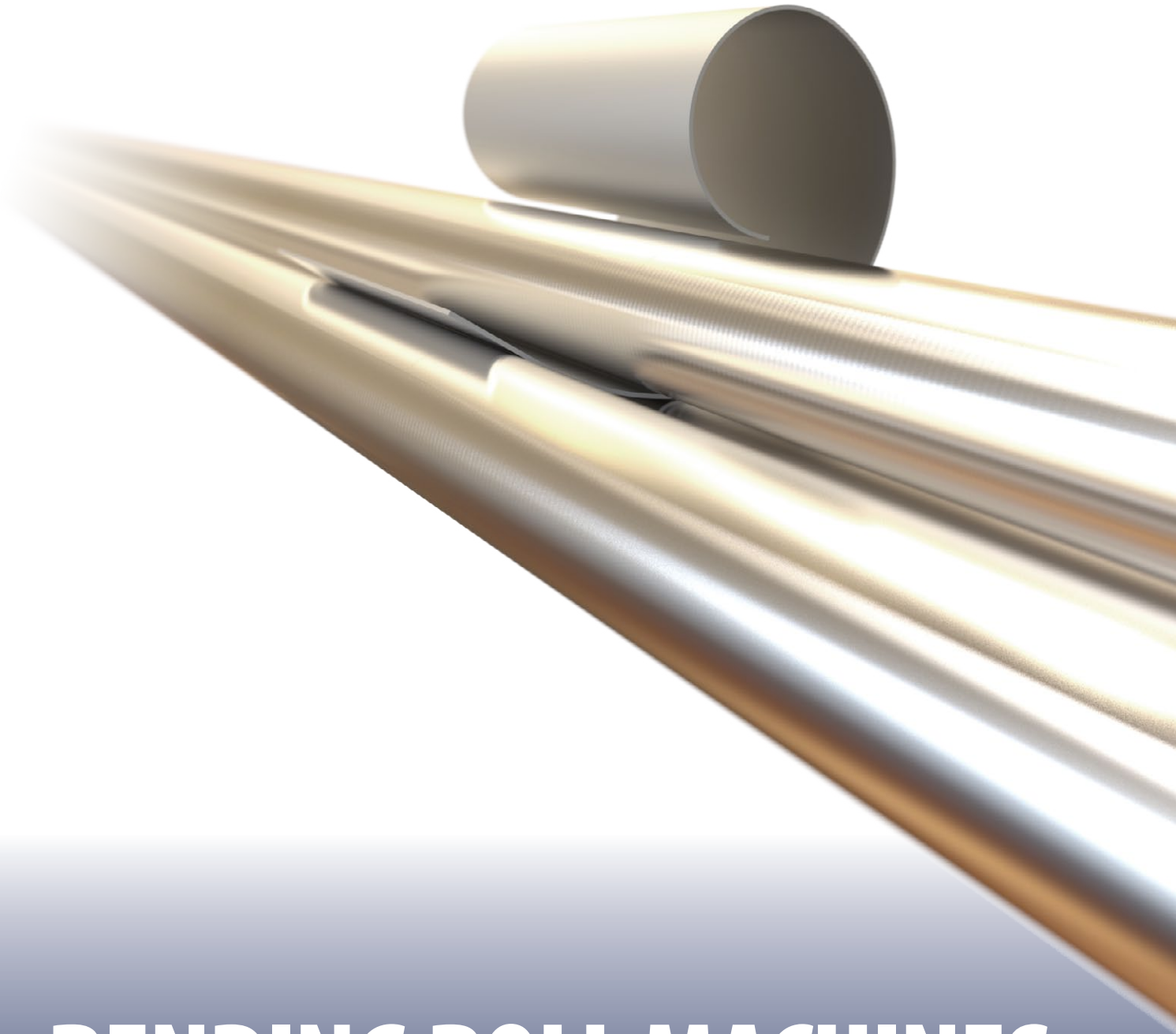

nosstec



BENDING ROLL MACHINES

MANUAL • DRIVEN • CNC



ABOUT THE COMPANY

Nosstec AB is part of the Nossebro Holding group of companies where Nosstec and the mechanical workshop Nossebro Mekaniska Verkstad can be found. In our group we work with the brands: Nosstec, Titan Rolls and Agromaskiner.

Our roots come from Nossebro Mekaniska Verkstad established in 1923 as a service company to the agricultural industry around the village Nossebro. Very soon the company grew and production of different products to the farmers in the area started. Later on when Lindahl & Nermark (today Luna) came in to the organization production of sheet metal working machines started in the early 70's. Luna was since then the main marketing partner worldwide. One product that especially began to grow was the bending roll machine and today we can proudly present a complete program of manual, driven as well as CNC controlled machines. Our CNC controlled machines were developed already 1994 and is today a sign of high accuracy and robust design for demanding customers in the industry.

As of 1st October 2012 Nosstec was established as a sales company where sheet metal working machinery branded as Nosstec will be exclusively marketed worldwide with assistance of a competent network of retailers. In the past the machines were known as Luna and HM.

Nosstec believe in a close contact between our production facility and our customers and based on this we can give you as customer a fast support as well as adaptations or developments that will meet your specific needs.

Welcome to Nosstec!

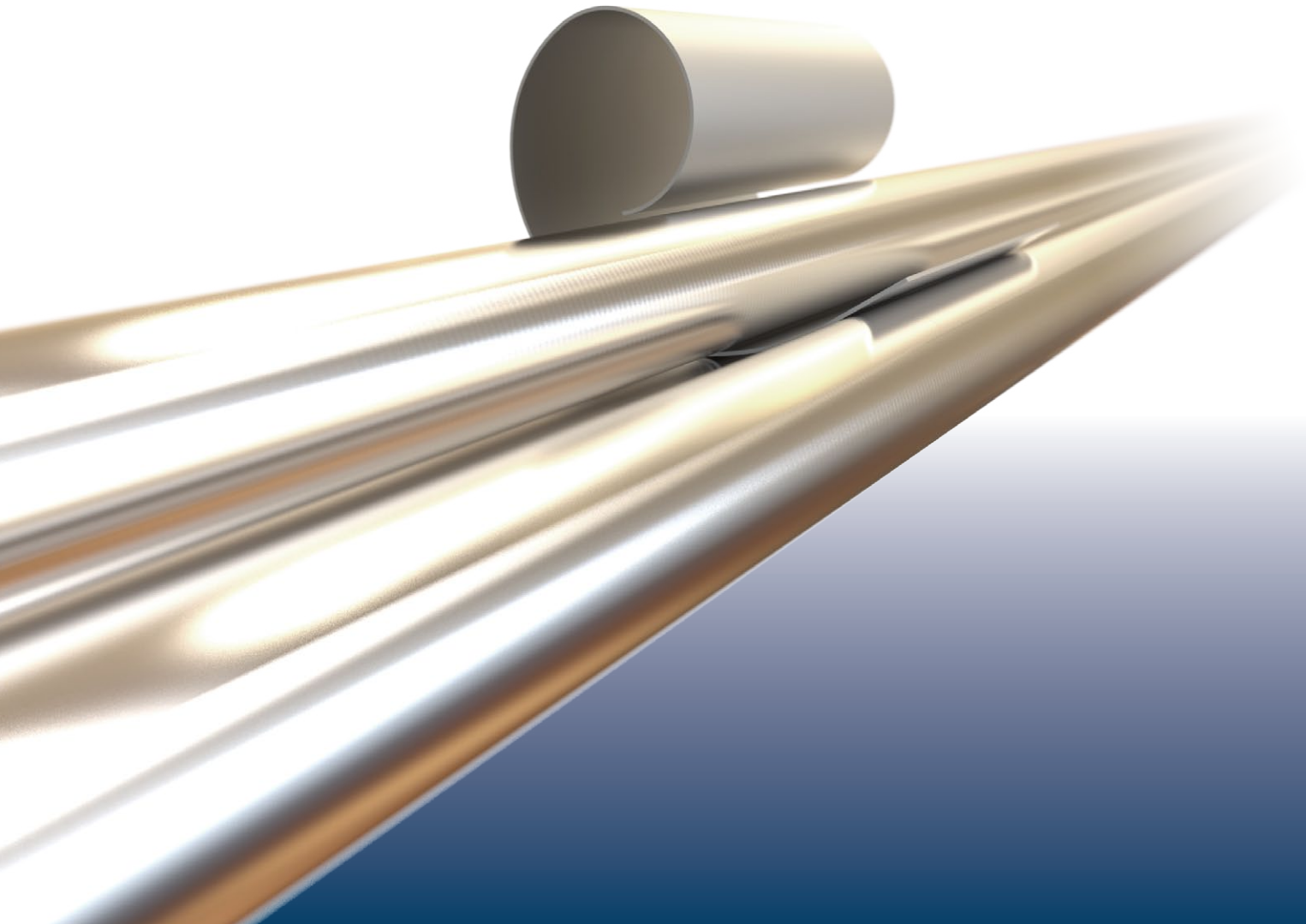

BENDING ROLLS TECHNOLOGY

Nosstec offers the market a wide variety of machines, independent if you need one for simple single piece bending roll work or if you produce high volumes of products with high requirements. As a bonus we will support you with a machine with the highest quality on the market.

Scope of capacities shown are based on mild carbon steel (400N/mm²)

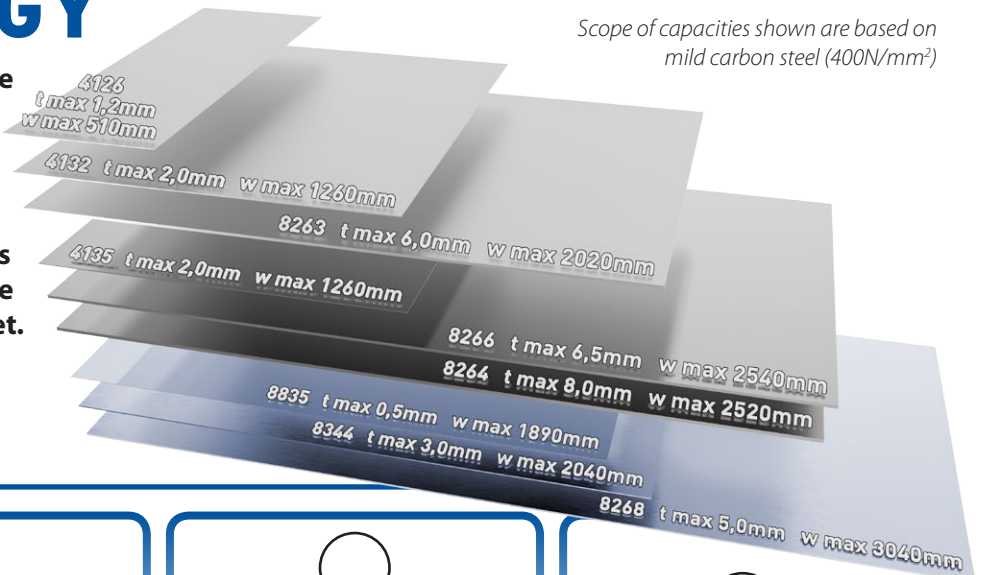

Roll setups

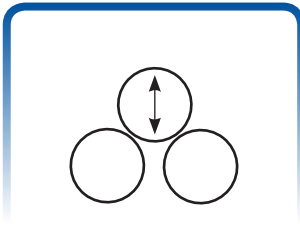

The basic setup suitable for less demanding applications but on the other hand a very robust solution. With this kind of setup no prebending is possible to perform.

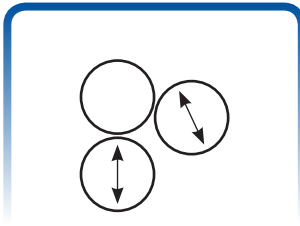

The most conventional setup for most of our machines. Prebending is possible and products of high quality can be produced.

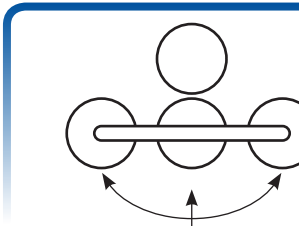

Setup used in our CNC machine 8344. Suitable for serial production. Very stable design with the lower rolls fixed on one rigid carrier

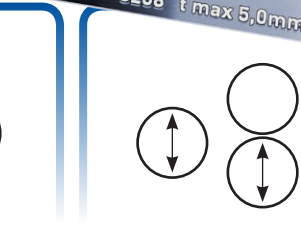

Setup used in our CNC machines 8268 and 8835. Individual rolls make advanced profiles possible with the most efficient cycle times.

Prebending

In order to produce round tubes or rounded profiles a prebending is a must. Our different roll setups work in different ways as shown here.

- Asymmetrical roll set-up where the sheet metal has to be run from the backside initially thereafter from the front.
- Fixed carrier on 8344 CNC machine make pre-bending and bending operation in the same run direction by tilting backward and forward.
- CNC machine 8268 with individual rolls give a very efficient prebending and bending process.
- CNC machine 8835 work in the same way as 8268 but no tubes can be produced since no lock arm is used for this reflector assigned machine.

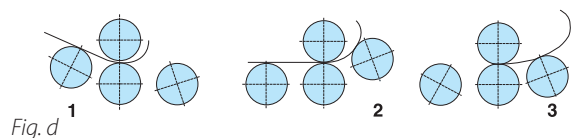
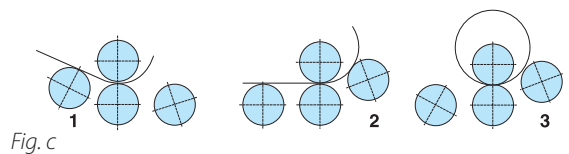
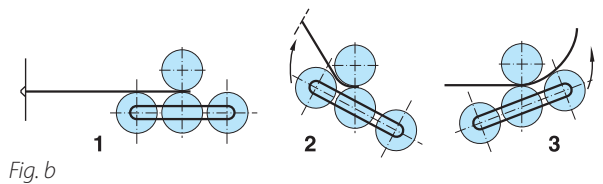
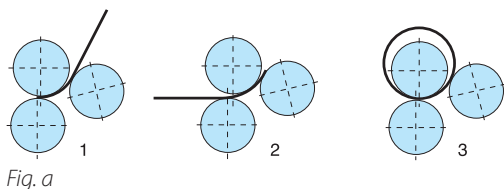

MANUAL

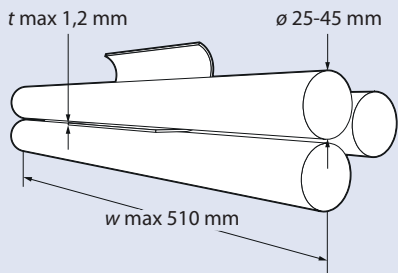

BENDING ROLL MACHINE 4126

Our smallest machine suitable for production of small products. Manually operated with centerless ground rolls dia. 25 to 45 mm. The sides are made of anodized and solid aluminium. The setting of the bottom and bending rolls is carried out by means of hand wheels. The bending roll can also be set diagonally for cone bending.

- ▶ Top roll can be swung out
- ▶ Cone bending as standard
- ▶ Light duty production



Stand

Art.no.	4126	-0208	-0209	-0306	-0307	-0310	-0312	-0508	-0509
Capacity		2/08	2/09	3/06	3/07	3/10	3/12	5/08	5/09
Working length (<i>w</i>)	mm	210	210	360	360	360	360	510	510
Max sheet thickness (400N/mm ²) (<i>t</i>)	mm	0,8	0,9	0,6	0,7	1,0	1,2	0,8	0,9
Diameter of rolls (<i>ø</i>)	mm	25	30	25	30	40	45	40	45
Net weight	kg	13	16	15	19	23	27	29	33
OPTIONS:									
Stand	4126	-0902	-0902	-1009	-1009	-1009	-1009	-1108	-1108

BENDING ROLL MACHINE 4132

A manually operated machine with crowned rolls. The lower roll is adjusted by means of a hand wheel on the right-hand side of the machine. The bending roll can be set diagonally for cone bending. The lower and rear rolls have four different slots for the bending of wire.

- ▶ Top roll can be swung out
- ▶ Cone bending as standard
- ▶ Reduction gear available for increased power
- ▶ Bending roll adjusted by lever
- ▶ Crowned rolls
- ▶ Medium duty production



Stand

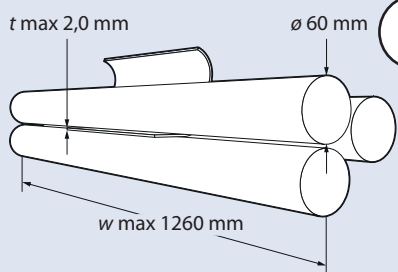

Art.no.	4132	-0620	-1015	-1212
Capacity		6/20	10/15	12/12
Working length (<i>w</i>)	mm	675	1010	1260
Max sheet thickness (400N/mm ²) (<i>t</i>)	mm	2,0	1,5	1,25
Diameter of rolls (<i>ø</i>)	mm	60	60	60
Net weight	kg	140	175	215
OPTIONS:				
Stand	4132	-0458	-0508	-0607

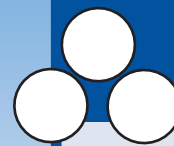

MANUAL

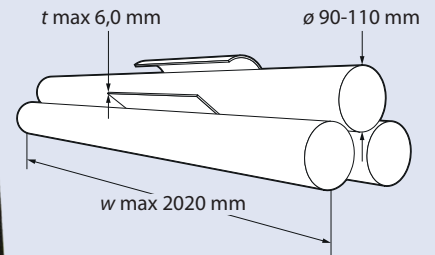

BENDING ROLL MACHINE 8263

Suitable for production of less demanding profiles, the 8263 is a manually operated machine made of cast iron. The lower rolls are fixed mounted while the upper roll is adjustable by means of two screw spindles. One side bracket can be bent outwards for the removal of finished piping.

- ▶ Basic and robust
- ▶ Cone bending optional
- ▶ Crowned rolls
- ▶ Heavy duty production

Art.no.	8263	-1035	-1050	-1060	-1230	-1240	-1250	-1525	-1535	-1540	-1715	-1725	-1730	-2010	-2015	-2020
Capacity		10/35	10/50	10/60	12/30	12/40	12/50	15/25	15/35	15/40	17/15	17/25	17/30	20/10	20/15	20/20
Working length (<i>w</i>)	mm	1020	1020	1020	1270	1270	1270	1525	1525	1525	1770	1770	1770	2020	2020	2020
Max sheet thickness (400 N/mm ²) (<i>t</i>)	mm	3,5	5,0	6,0	3,0	4,0	5,0	2,5	3,5	4,0	1,5	2,5	3,0	1,0	1,5	2,0
Diameter of rolls (<i>ø</i>)	mm	90	100	110	90	100	110	90	100	110	90	100	110	90	100	110
Net weight	kg	295	410	460	330	450	510	355	490	560	400	530	610	435	570	660
OPTIONS:																
Hardened and ground rolls	826377	-1035	-1050	-1060	-1230	-1240	-1250	-1525	-1535	-1540	-1715	-1725	-1730	-2010	-2015	-2020
Cone bending equipment	8263	-2605	-2605	-2605	-2605	-2605	-2605	-2605	-2605	-2605	-2605	-2605	-2605	-2605	-2605	-2605

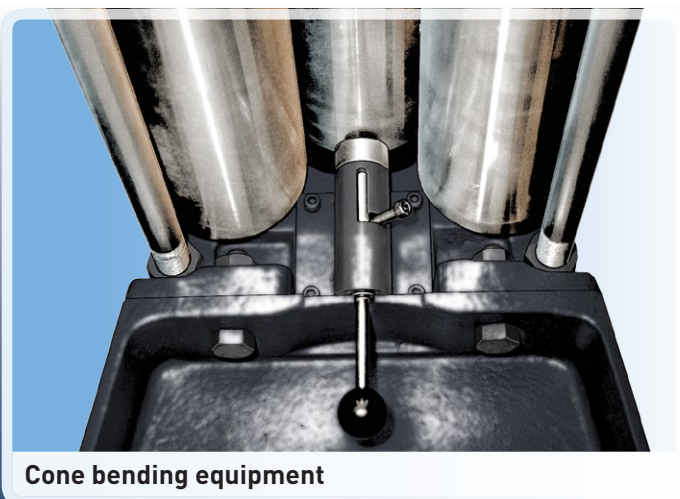

Cone bending equipment

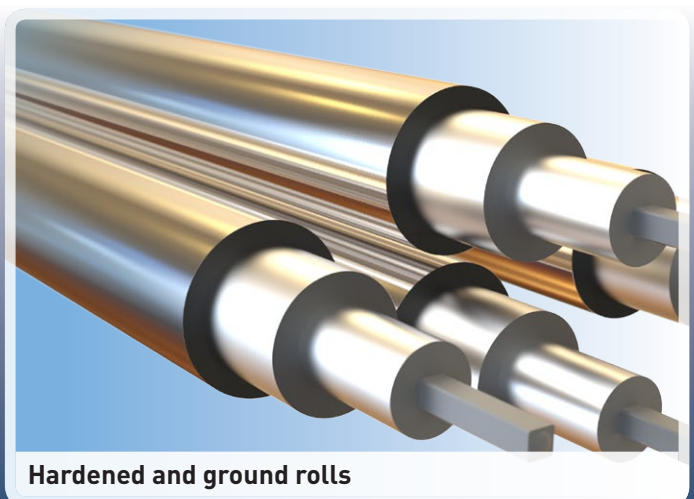

Hardened and ground rolls

DRIVEN

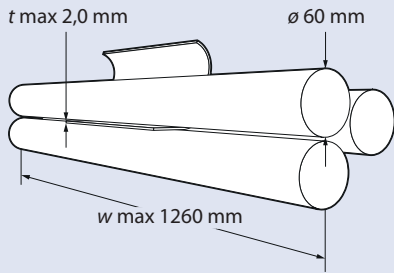

BENDING ROLL MACHINE 4135

A motor-powered machine with crowned rolls. The lower roll is adjusted by a handwheel. The lower and rear rolls have four different slots for the bending of wire. 4135 is delivered complete with motor 400V 3-phase, stand as well as foot-operated forward/reverse switch with protective casing. The electrical equipment as per protection form IP54.

- ▶ Top roll can be swung out
- ▶ Cone bending as standard
- ▶ Bending roll adjusted by lever
- ▶ Crowned rolls
- ▶ Medium duty production



Frequency inverter



Digital display

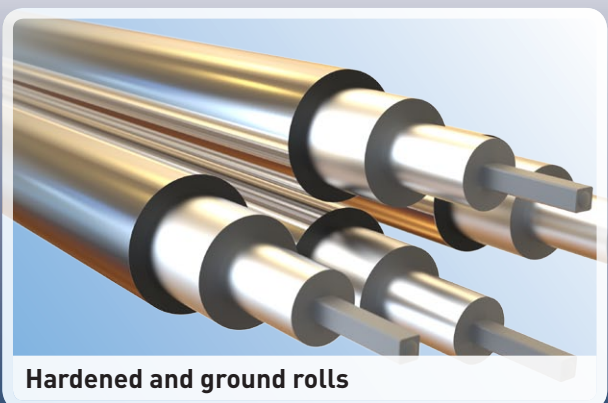

Hardened and ground rolls

Art.no.	4135	-0620	-1015	-1212	-1508
Capacity		6/20	10/15	12/12	15/08
Working length (w)	mm	675	1010	1260	1510
Max sheet thickness (400N/mm ²) (t)	mm	2,0	1,5	1,25	0,8
Diameter of rolls (\varnothing)	mm	60	60	60	60
Motor rating	kW	0,5	0,5	0,5	0,5
Net weight	kg	180	215	255	295
OPTIONS:					
Hardened and ground rolls	413577	-0620	-1015	-1212	-1508
Digital readout	4135	-4002	-4002	-4002	-4002
Frequency inverter	4135	-0604	-0604	-0604	-0604

DRIVEN

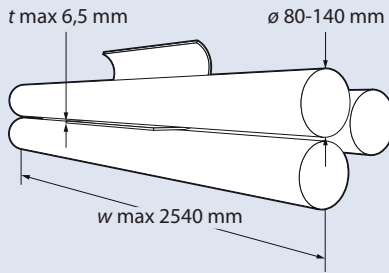

BENDING ROLL MACHINE 8266

Our universal machine for medium and heavy duty production, suitable for most applications. Motor-powered with crowned rolls in needle bearings. The setting of the upper and lower rolls is by hand wheels via wormgears. The upper and lower rolls are driven by a worm gear motor. All transmission is built into one side of the machine making it a very compact design. Plenty of options available. The electrical equipment as per protection form IP54.

Art.no.	8266	-1025	-1030	-1040	-1050	-1055	-1060	-1065	-1220	-1225	-1235	-1245
Capacity		10/25	10/30	10/40	10/50	10/55	10/60	10/65	12/20	12/25	12/35	12/45
Working length (w)	mm	1040	1040	1040	1040	1040	1040	1040	1290	1290	1290	1290
Max sheet thickness (400 N/mm ²) (t)	mm	2,5	3,0	4,0	5,0	5,5	6,0	6,5	2,0	2,5	3,5	4,5
Diameter of rolls (\varnothing)	mm	80	90	100	110	120	130	140	80	90	100	110
Motor rating	kW	0,75	0,75	1,1	1,1	1,1	2,2	2,2	0,75	0,75	1,1	1,1
Net weight	kg	400	440	665	700	745	960	1015	440	490	725	770
OPTIONS:												
Hardened and ground rolls	826677	-1025	-1030	-1040	-1050	-1055	-1060	-1065	-1220	-1225	-1235	-1245

Art.no.	8266	-1250	-1255	-1260	-1515	-1520	-1530	-1540	-1545	-1550	-1555	-2010
Capacity		12/50	12/55	12/60	15/15	15/20	15/30	15/40	15/45	15/50	15/55	20/10
Working length (w)	mm	1290	1290	1290	1540	1540	1540	1540	1540	1540	1540	2040
Max sheet thickness (400 N/mm ²) (t)	mm	5,0	5,5	6,0	1,5	2,0	3,0	4,0	4,5	5,0	5,5	1,0
Diameter of rolls (\varnothing)	mm	120	130	140	80	90	100	110	120	130	140	80
Motor rating	kW	1,1	2,2	2,2	0,75	0,75	1,1	1,1	1,1	2,2	2,2	0,75
Net weight	kg	825	1055	1120	480	530	785	840	905	1140	1220	560
OPTIONS:												
Hardened and ground rolls	826677	-1250	-1255	-1260	-1515	-1520	-1530	-1540	-1545	-1550	-1555	-2010

Art.no.	8266	-2015	-2020	-2025	-2030	-2035	-2040	-2510	-2515	-2520	-2525	-2530
Capacity		20/15	20/20	20/25	20/30	20/35	20/40	25/10	25/15	25/20	25/25	25/30
Working length (w)	mm	2040	2040	2040	2040	2040	2040	2540	2540	2540	2540	2540
Max sheet thickness (400 N/mm ²) (t)	mm	1,5	2,0	2,5	3,0	3,5	4,0	1,0	1,5	2,0	2,5	3,0
Diameter of rolls (\varnothing)	mm	90	100	110	120	130	140	100	110	120	130	140
Motor rating	kW	0,75	1,1	1,1	1,1	2,2	2,2	1,1	1,1	1,1	2,2	2,2
Net weight	kg	625	905	975	1060	1320	1425	1025	1110	1225	1500	1630
OPTIONS:												
Hardened and ground rolls	826677	-2015	-2020	-2025	-2030	-2035	-2040	-2510	-2515	-2520	-2525	-2530

Optional equipment



Digital display available for bending and/or lower rolls



Cone bending equipment, includes diagonal setting of bending roll, trailing shoe and handwheel with dial register



Control panel



Frequency inverter



Diagonal setting of lower roll

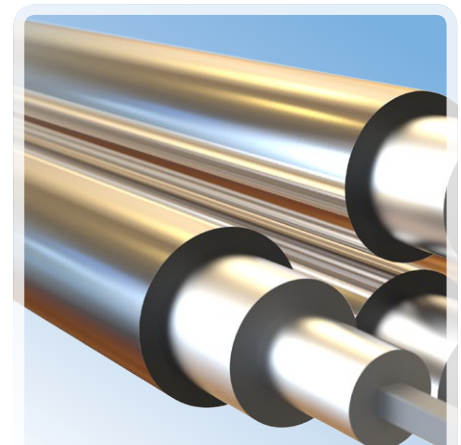

Hardened and ground rolls

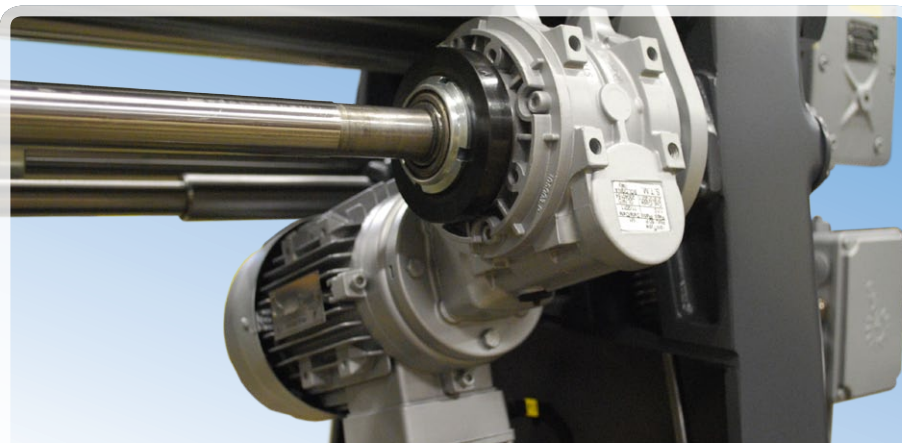

Motor-powered bending and/or lower roll

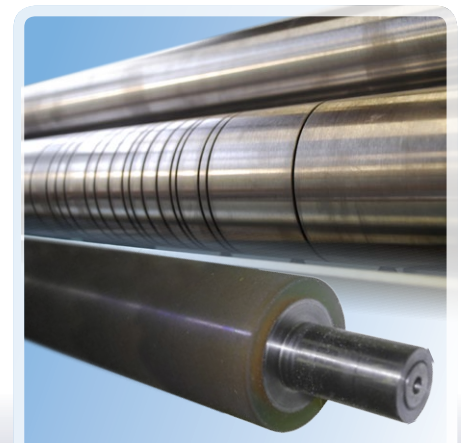

Special rolls

Optional equipment	Art.no.
Cone bending equipment (includes diagonal setting of bending roll, trailing shoe and hand wheel with dial register)	8266-0556
Diagonal setting of lower roll	8266-4715
Motor-powered bending roll, fixed control panel	8266-08041
Motor-powered lower roll, fixed control panel	8266-30551
Motor-powered bending roll, portable control panel	8266-08042
Motor-powered lower roll, portable control panel	8266-30552
Digital readout (together with cone bending equipment, the digital readout substitutes the dial register)	8266-4723
Frequency inverter	8266-4301

On request: Adiprene-coated rolls, Grooves in rolls, 230V 3-phase

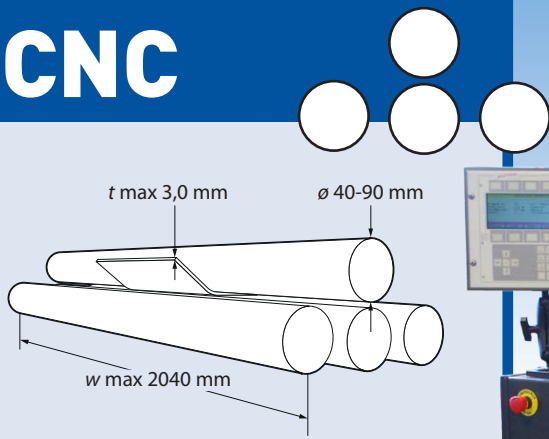

BENDING ROLL MACHINE 8344

Suitable for small to medium production as well as complex shapes, the 8344 CNC can bend profiles with variable radii and sections. The design with three lower bending rolls, mounted in a cassette, which is swivelling and adjustable in height, enables bending of very complex profiles in one single operation. The three rolls of the cassette are used as prebending roll, bottom roll and final bending roll. The cassette system also allows exchange of the rolls to other dimensions (applies to 70, 80 and 90 mm). The special design of the machine and the location of the four rolls eliminate all intermediate handling of the sheet between the prebending and the final bending. This simplified working method also means that the storage space around the machine can be reduced, a higher repetition accuracy is achieved as well as a higher productivity.

The adjustment of the cassette into the programmed position is carried out by means of ball screws. When bending is finished the lock clamp on the right hand side opens for

the removal of the profile, if the profile is not closed, this function can be eliminated in the control program.

As standard the machine is delivered with hardened and ground rolls, motor 400V 3-phase and 24V control voltage.

- ▶ CNC-control with the capacity to store 200 programs in internal memory and nearly unlimited by attaching an external USB flash drive
- ▶ Pre-bending and final bending in one cycle
- ▶ All four rolls are driven
- ▶ Crowned rolls
- ▶ Programmable axis
- ▶ Designed for highest accuracy
- ▶ Rolls mounted in changeable cassette system
- ▶ Openable locking arm
- ▶ Adjustable crowning of the lower roll
- ▶ Program backup through external computer or attached USB flash drive



The 8344 $\varnothing 40\text{mm}$ machine equipped with cassette for louvers and reflectors

The design of the machine is based on the same principles as the other models of the 8344 series with the exception of the cassette. The rolls are here provided with roller supports along the whole bending length for adjustable crowning of the rolls.

The rolls are hardened and have chromium-plated and polished surfaces in order to avoid marks in the sheet. The crowning of the top roll is carried out by means of a crossbeam, which tilts 90 degrees to the cradle, to make room for the bent part of the sheet. The machine with 40 mm diameter rolls is only intended to form aluminium.

Simple to use control panel

The programming of the machine is facilitated by different menus available on the screen. In order to further simplify the programming, the control buttons are of multi-function type, whose functions are automatically changed when changing menus. The CNC has a internal storage capacity of 200 programs or near unlimited with an external USB flash drive.

The program consists of sections, where each section is provided with a bending value. This enables easy and quick programming of the machine for different bending operations. The CNC system can operate with interpolation, where the rolls are adjusted simultaneously with the feeding operation.

Optional equipment

- ▶ Adjustable crowning support
- ▶ Chromium-plated rolls
- ▶ Adiprene-coated rolls or rolls with grooves
- ▶ Stacking tables
- ▶ Programmable support arm
- ▶ Additional safety equipment
- ▶ Infeed and outfeed equipment

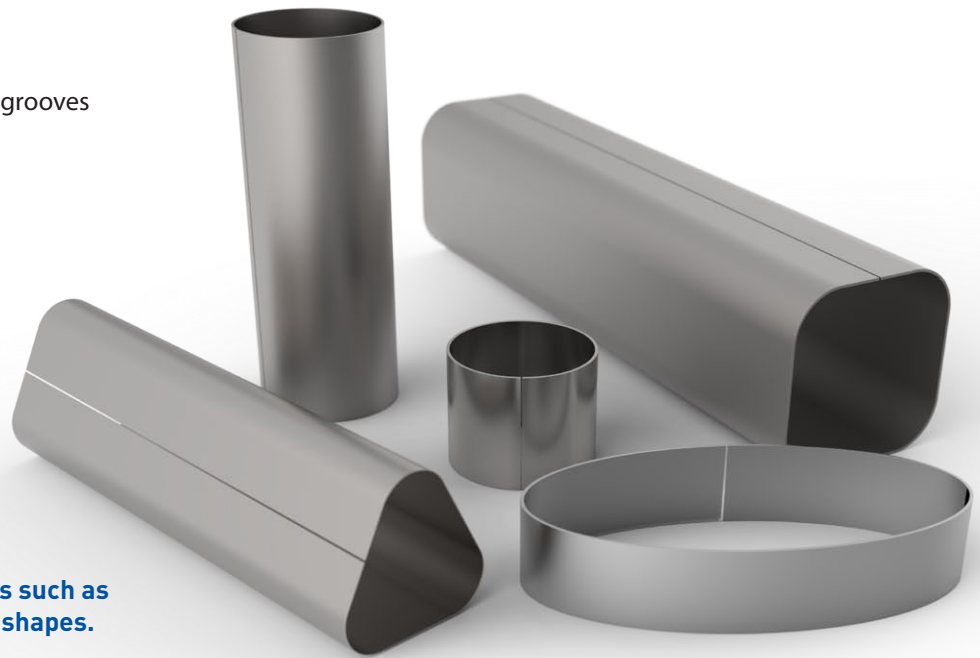

Product applications such as tubes and elliptical shapes.

Art.no.	8344	-401010	-401208	-401507	-401706	-402005
Capacity		10/10	12/08	15/07	17/06	20/05
Working length (w)	mm	1008	1258	1508	1750	2008
Max. sheet thickness Alu (250 N/mm ²) (t)	mm	1,0	0,8	0,7	0,6	0,5
Diameter of rolls (Ø)	mm	40	40	40	40	40
Motor output	kW	0,75	0,75	0,75	0,75	0,75
Max. working speed	m/min	4,6	4,6	4,6	4,6	4,6
Net. weight	kg	650	700	750	800	850

Art.no.	8344	-550715	-600720	-601010	-701020	-801025	-901030	-601208	-701215	-801220
Capacity		7/15	7/20	10/10	10/20	10/25	10/30	12/08	12/15	12/20
Working length (w)	mm	740	740	1020	1040	1040	1040	1250	1290	1290
Max. sheet thickness steel (400 N/mm ²) (t)	mm	1,5	2,0	1,0	2,0	2,5	3,0	0,8	1,5	2,0
Diameter of rolls (Ø)	mm	55	60	60	70	80	90	60	70	80
Motor output	kW	0,75	0,75	0,75	0,75	0,75	0,75	0,75	0,75	0,75
Max. working speed	m/min	6,3	6,9	6,9	8,1	9,2	10,4	6,9	8,1	9,2
Net. weight	kg	650	650	650	650	700	750	700	700	750

Art.no.	8344	-901225	-701510	-801515	-901520	-701707	-801712	-901716	-802010	-902015
Capacity		12/25	15/10	15/15	15/20	17/07	17/12	17/16	20/10	20/15
Working length (w)	mm	1290	1540	1540	1540	1790	1790	1790	2040	2040
Max. sheet thickness steel (400 N/mm ²) (t)	mm	2,5	1,0	1,5	2,0	0,7	1,2	1,6	1,0	1,5
Diameter of rolls (Ø)	mm	90	70	80	90	70	80	90	80	90
Motor output	kW	0,75	0,75	0,75	0,75	0,75	0,75	0,75	0,75	0,75
Max. working speed	m/min	10,4	8,1	9,2	10,4	8,1	9,2	10,4	9,2	10,4
Net. weight	kg	800	750	800	850	800	825	875	850	900

The prebending value is ca 70% of the indicated material.

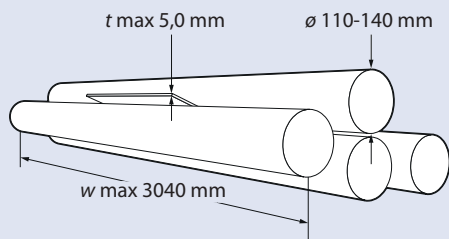
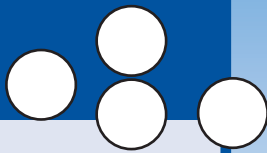

BENDING ROLL MACHINE 8268

Suitable for small to medium production and demanding applications, the 8268 is designed to meet the requirements for longer CNC rolls for tight radius bending. A welded steel frame and cast guides provide the necessary rigidity. The design with three rolls (pre-bending, bottom and bending roll) mounted independently in separate guides enables high productivity and easy adjustment of the rolls. The top roll is mounted above the middle roll making this machine a four-roll bender with symmetrically placed rolls. In order to control the bending result over the working length, the machine can be equipped with hydraulic crowning supports for the lower roll. This is carried out by three support blocks with four pressure bearings. The crowning is adjusted with a hand pump.

All four rolls are driven in order to prevent scratches on easily damaged sheets from slipping rolls. The movement of the three lower rolls is carried out by lead screws. The four-roll system eliminates the need for any intermediate handling of the sheet between pre-bending and final bending. This ensures high repetition accuracy as well as a rapid and rational production. When the bending is finished the lock clamp on the right hand side opens to allow removal of the bent profile. This function can be eliminated in the program. As standard the machine is delivered with hardened and ground rolls, motor 400V 3-phase and 24V control voltage.

- ▶ CNC-control with the capacity to store 200 programs in internal memory and nearly unlimited by attaching an external USB flash drive
- ▶ Pre-bending and final bending in one cycle
- ▶ All four rolls are driven
- ▶ Crowned rolls
- ▶ Programmable axis
- ▶ Designed for highest accuracy
- ▶ Adjustable crowning of the lower roll
- ▶ Program backup through external computer or attached USB flash drive

Product applications such as tubes and elliptical shapes.



Art.no.	8268	-1540	-1545	-1550	-1555	-2025	-2030	-2035	-2040	-2515	-2520	-2525	-2530	-3015	-3020
Capacity		15/40	15/45	15/50	15/55	20/25	20/30	20/35	20/40	25/15	25/20	25/25	25/30	30/15	30/20
Working length (w)	mm	1540	1540	1540	1540	2040	2040	2040	2040	2540	2540	2540	2540	3040	3040
Max. sheet thickness (400 N/mm ²) (t)	mm	4,0	4,5	5,0	5,5	2,5	3,0	3,5	4,0	1,5	2,0	2,5	3,0	1,5	2,0
Diameter of rolls (ø)	mm	110	120	130	140	110	120	130	140	110	120	130	140	130	140
Motor output feeding motor	kW	2,2	2,2	2,2	2,2	2,2	2,2	2,2	2,2	2,2	2,2	2,2	2,2	2,2	2,2
Net. weight	kg	1800	1800	2100	2400	1800	2100	2400	2700	1800	2400	2700	3000	3000	3300

The prebending value is ca 70% of the indicated material.



Simple to use control panel

The programming of the machine is facilitated by different menus available on the screen. In order to further simplify the programming, the control buttons are of multi-function type, whose functions are automatically changed when changing menus.

The CNC has a internal storage capacity of 200 programs or near unlimited with an external USB flash drive. The program consists of sections, where each section is provided with a bending value. This enables easy and quick programming of the machine for different bending operations.

The CNC system can operate with interpolation, where the rolls are adjusted simultaneously with the feeding operation.

Optional equipment

- ▶ Adjustable crowning support
- ▶ Chromium-plated rolls
- ▶ Adiprene-coated rolls
- ▶ Rolls with grooves
- ▶ Stacking tables
- ▶ Programmable support arm
- ▶ Additional safety equipment
- ▶ Infeed and outfeed equipment



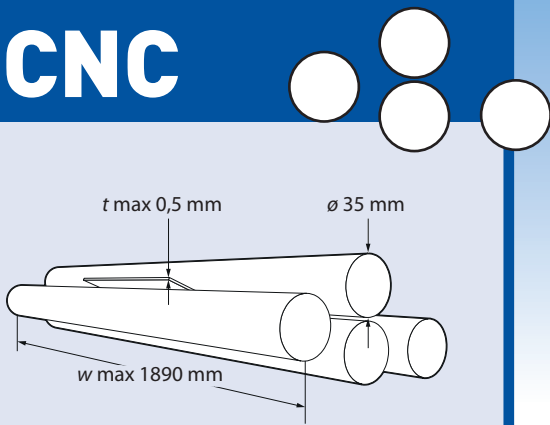

BENDING ROLL MACHINE 8835

The 8835 is a bending roll machine for the production of small radius louvres and reflectors to meet the demands of the latest small diameter light tubes.

The machine is designed with three independent bottom rolls to reduce production time to a minimum. All rolls run in adjustable support bearings to permit easy roll adjustment for materials of different hardness and thickness. The top roll crowning is carried out by means of a crossbeam, which tilts to make room for the bent part. All rolls are hardened and chromium-plated with polished surfaces to avoid marking. All four rolls are driven in order to avoid scratches on easily damaged sheets from slipping rolls. The control system allows programming of constant radius parts as well as parabolic shapes.

- ▶ CNC-control with the capacity to store 200 programs in internal memory and nearly unlimited by attaching an external USB flash drive
- ▶ Pre-bending and final bending in one cycle
- ▶ All four rolls are driven
- ▶ Crowned rolls
- ▶ Programmable axis
- ▶ Designed for highest accuracy
- ▶ Front-roll or back-roll position can be programmed to flexibly vary bend diameter
- ▶ Adjustable crowning of the rolls
- ▶ Program backup through external computer or attached USB flash drive

Art.no.	8835	-1805
Capacity		18/05
Working length (w)	mm	1890
Max. sheet thickness steel (250 N/mm ²) (t)	mm	0,5
Diameter of rolls (\varnothing)	mm	35
Motor output	kW	0,75
Max. working speed	m/min	9,1
Net. weight	kg	900

Simple to use control panel

The programming of the machine is facilitated by different menus available on the screen. In order to further simplify the programming, the control buttons are of multi-function type, whose functions are automatically changed when changing menus. The CNC has an internal storage capacity of 200 programs or near unlimited with an external USB flash drive.



The program consists of sections, where each section is provided with a bending value. This enables easy and quick programming of the machine for different bending operations. The CNC system can operate with interpolation, where the rolls are adjusted simultaneously with the feeding operation.

Optional equipment

- ▶ Stacking tables
- ▶ Infeed automation
- ▶ Outfeed automation
- ▶ Online feeding unit 1700

Online feeding unit 1700

The unit consists of a driven roller way and a pneumatic pushing device for pushing the blanks (Alu-sheets) into the roller. The concept makes it possible to integrate a punching line with 8835/8344. Unit 1700 is equipped with a slave computer connected to the control system of the bending roll. The unit can be installed or removed in about 5 min.

Product application examples.

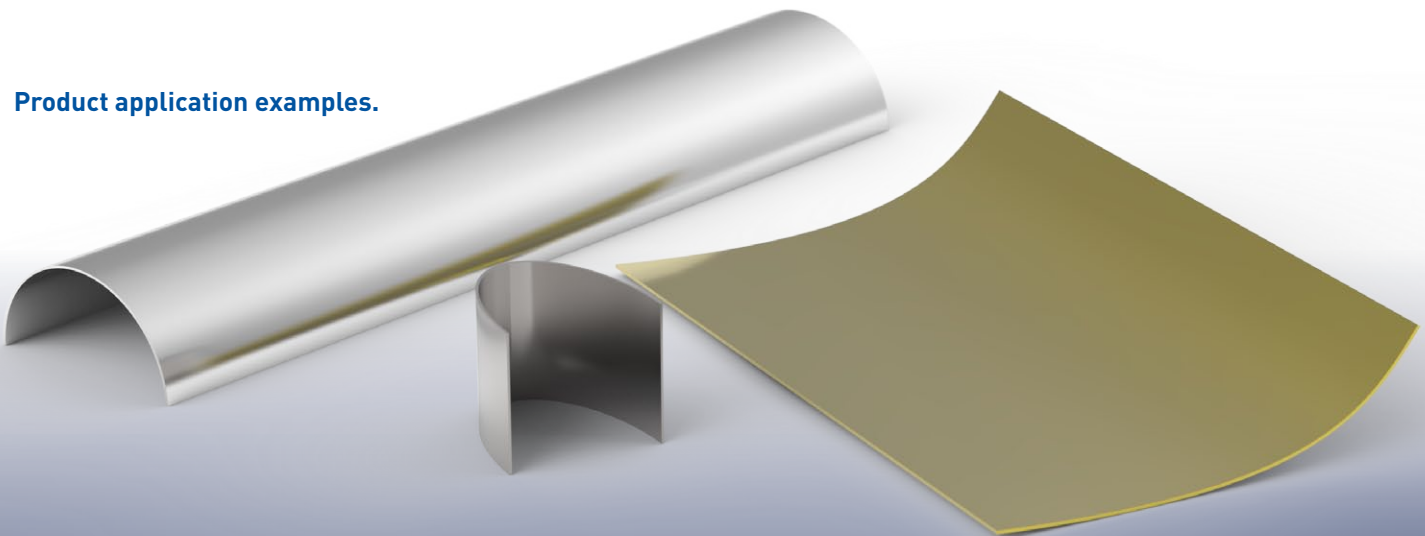

NOSSTEC REPRESENTATIVE:

CONTACT INFORMATION

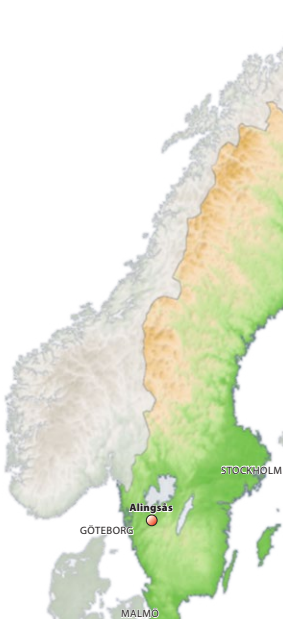

Nosstec's main office with sales and administration is located in Alingsås, a city with long tradition in steel and sheet metal working machinery and equipment. Alingsås is located about 50km east of Gothenburg.

The production facility Nossebro Mekaniska Verkstad is located in Nossebro, further 45 km north east of Alingsås, where also our Demo- and Testcenter can be found.



Nosstec AB, Kristineholmsvägen 12, 441 39 Alingsås, SWEDEN

Tel: +46 (0)512 - 298 85 • Fax: +46 (0)512 - 298 89

E-mail: info@nosstec.se • Web: www.nosstec.se

For copyright reasons all reproduction and copying of the texts, photos, tables and illustrations within this brochure is prohibited without written permission from Nosstec AB.